



NUT 012 . Ed. 6

June 2010

User's manual

## Model 1120

# 1pS Time Interval Meter



- Two Channels (Start, Stop),
- < 1 ps one-shot resolution,
- < 10 ps rms jitter,
- $\pm 1$  s time measurement range,
- Rack 19", 1U,
- Ethernet interface.

Total sheets: 36

## CONTENT

<b>1. GENERAL INFORMATION.....</b>	<b>5</b>
1.1. POWER INSTALLATION.....	6
1.2. OPERATING TEMPERATURE .....	6
1.3. RACK MOUNTING INFORMATION .....	6
1.4. SELF-TEST.....	6
<b>2. SPECIFICATIONS.....</b>	<b>7</b>
<b>3. OPERATING INFORMATION .....</b>	<b>9</b>
3.1. PRINCIPLE:.....	9
3.1.1. <i>block diagram</i> .....	9
3.1.2. <i>Time interval mode</i> .....	9
3.1.3. <i>Event mode</i> .....	10
3.1.4. <i>Auto-calibration</i> .....	10
3.1.5. <i>10 MHz Time base</i> .....	10
3.1.6. <i>Arming mode</i> .....	11
3.2. FRONT PANEL OPERATION .....	12
3.2.1. <i>Interface</i> .....	12
3.2.2. <i>Display menu</i> .....	13
3.2.3. <i>IP adress</i> .....	15
3.2.4. <i>Default value</i> .....	16
3.3. REAR PANEL OPÉRATION .....	16
<b>4. CONNECTING TO THE INSTRUMENT VIA ETHERNET .....</b>	<b>17</b>
4.1. COMMAND STRUCTURE .....	17
*IDN?.....	17
ARM.....	17
CAL.....	18
COUNT.....	18
DELAY.....	18
DFORMAT.....	19
JITTER.....	19
LEVEL.....	20
MODE.....	20
POL.....	21
RESULTS.....	22
RUN.....	23
SAMPLES.....	23
STAT.....	24
STOP.....	25
TRIG.....	25
4.2. REMOTE CONTROLE VIA INTERNET (WEB PAGE) .....	26
4.2.1. <i>Results web page</i> .....	26
4.2.2. <i>Set up web page</i> .....	27
4.2.3. <i>Status web page</i> .....	28
4.3. REMOTE CONTRÔLE VIA ETHERNET .....	28
<b>5. OPERATION EXAMPLES.....</b>	<b>29</b>
5.1. EXAMPLE 1 .....	29
5.2. EXAMPLE N°2 .....	30
<b>6. ANNEXE : OPTION 1 OPTICAL MESSAGE .....</b>	<b>31</b>
6.1. FRONT PANEL OPERATION .....	31
6.1.1. <i>Display menu</i> .....	31

6.1.2. IP adress .....34  
6.1.3. Command structure .....35  
STAT .....35  
SYNC .....36  
TRIG .....36

**EDITION**

Ed.	Date	Description
1 4	18/01/2011	Creation
5	12/12/2008	Update the document to correct some bugs
6	08/06/2010	Command STAT SCAN

## 1. GENERAL INFORMATION

The BNC 1120 – 1pS Time Interval Counter measures time interval, frequency and events.

The single-shot resolution and low jitter of the instrument make it the ideal for many test and measure application.

Time intervals are measured with 1 ps resolution. Frequency and events are measured up to 10 MHz

Trigger level and slope are adjustable on each input. The instrument uses a linear interpolation technique and an internal calibration to obtain very high accuracy.

All the BNC 1120 parameters may be local controlled (over the front panel keys and LCD display) and remote controlled via an Ethernet interface.

### Instrument Option:

- Option 1: Optical triggered,

In timing system mode the module could be triggered by BNC 575 Digital Delay and Pulse Generator via an optical signal.

### Technical support

For more information about operating the BNC 1120, send an email to [info@berkeleynucleonics.com](mailto:info@berkeleynucleonics.com).

### Package contents

The box you receive should contain the following:

- BNC 1120 instrument,
- User's manual,
- Power cord,
- CD contains pdf user manual.

## 1.1. Power installation

### Power source

The BNC 1120 can be operated from 110 VAC to 220 VAC nominal supply source.  
The maximum power consumption of the BNC 1120 is 45 W.

### Power cord

The BNC 1120 comes with a removable power cord for European usage. It has a three contact plug for connection to both the power source and protective ground.

## 1.2. Operating temperature

The instrument can be operated where the ambient air temperature is 0°C to 35°C and can be stored in ambient temperature from -10°C to +60°C.  
The BNC 1120 is cooled by air circulation. To prevent instrument damage a clearance of 2 inches on the side and 1 inch on the rear must be maintained for proper cooling.

## 1.3. Rack mounting information

The BNC 1120 will fit a 19 inch rack.

## 1.4. Self-test

The BNC 1120 is automatically tested after power on (power supply and temperature).

If the power supply is not ok, the BNC 1120 indicate power failure.

## 2. SPECIFICATIONS

<b>Inputs start or stop</b>		
	Threshold	-5 to +5 V
	Slope	Rising or falling edge
<b>Input gate</b>		
	Threshold	+1.5 V (fixed)
	Trigger rate	0 to 20 KHz
<b>Time interval</b>		
	Range	-1 to + 1 second
	Trigger rate	0 to 20 kHz
	Resolution	< 1ps, single shot
	Error	< 250 ps + time interval x 10 <sup>-9</sup>
	RMS jitter	10 ps
	Arming mode	On start, on stop, on gate
<b>Event counting</b>		
	Range	0 to 10 000 000
	Count rate	0 to 10 MHz
	Gate	Internal 1 s, external on input gate
<b>System</b>		
	Calibration	Internal
	Functions	Time interval, event counting
<b>Output 10 MHz</b>		
	Signal	Square wave, 2.5 V pp, ac coupling
<b>Input 10 MHz</b>		
	Signal	1 V nominal (automatic detection)

<b>Clock</b>		
	Time base	10 MHz ovenized
	Stability	+/- 0.05 ppm
	Accuracy	10 <sup>-9</sup>
<b>Interface</b>		
	Front panel, Ethernet 10/100 Mb/s, Internet (Web page)	
<b>General</b>		
	Power required	90 – 220 V / 50 – 60 Hz
	Weight	< 10 Kg
	Dimensions	19", 1 U, 300 mm



### 3. OPERATING INFORMATION

#### 3.1. Principle:

##### 3.1.1. block diagram

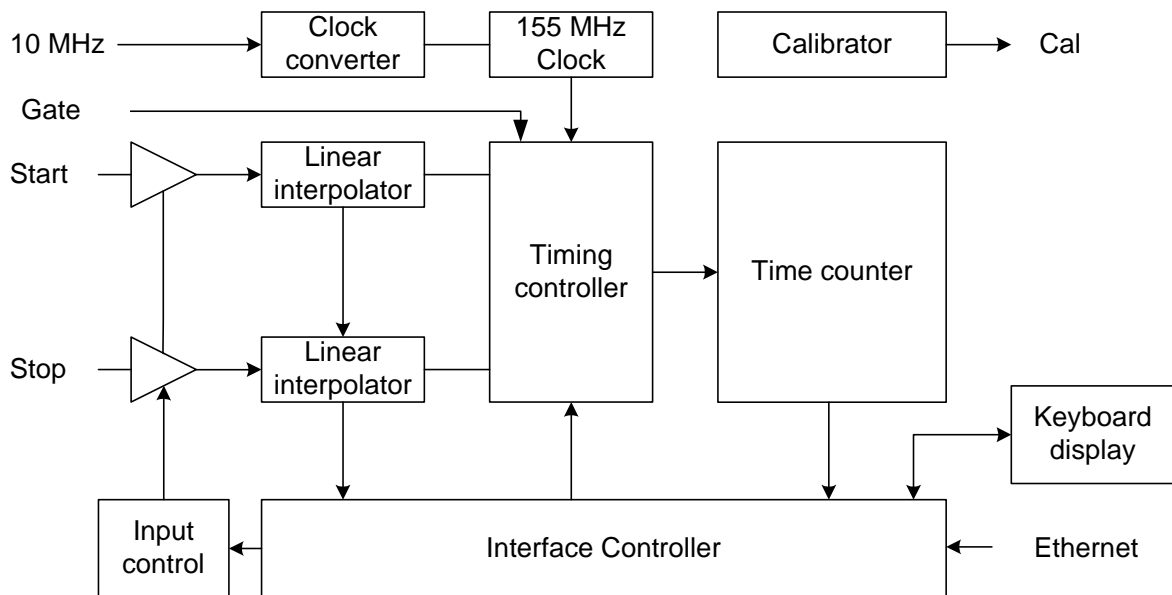

##### 3.1.2. Time interval mode

In timing interval mode the BNC 1120 measures the time between a Start and Stop pulse. The timing information is obtained by a processing that combines the two following information:

- Coarse information provided by a wide range Time counter running at 155.52 MHz (6.43 ns resolution),
- And fine information provided by the two linear interpolators started by the event on the Start and Stop inputs.

A gate input can be used to enable or disable all Start and Stop events as desired.

The BNC 1120 can make positive or negative time measurements. The start pulse can occur before or after the stop pulse.

The number of sequence measurement can be controlled by the “sequence” command single/repetitive. In repetitive sequence the number of measurement is controlled by the value write in “sample” command.

### 3.1.3. Event mode

In this mode the BNC 1120 counts events at Start and at Stop inputs.

Event counting can be gated:

- Internally with a gate ranging of 1 second,
- Externally through the duration of input gate.

The trigger level and slope for a transition event are adjustable on both the Start and Stop inputs.

Event rate up to 10MHz can be counted with a maximum of 10 000 000 digits.

### 3.1.4. Auto-calibration

The BNC 1120 has a powerful built-in auto-calibration routine that compensates the nonlinearities in time to digital converter. The auto-calibration is done through a software command and takes about 30 seconds to be performed.

To calibrate the BNC 1120, send an Ethernet command or send CALIBRATE with the front panel.

### 3.1.5. 10 MHz Time base

The accuracy of the BNC 1120 depends of the quality of the selected time base.

The internal 10MHz standard time base is an ovenized oscillator with stability of  $\pm 0.005$  ppm.

A rear panel input allows you to connect an external 10MHz source as a time base.

### 3.1.6. Arming mode

The BNC 1120 has 3 arming modes:

- ARM ON START,

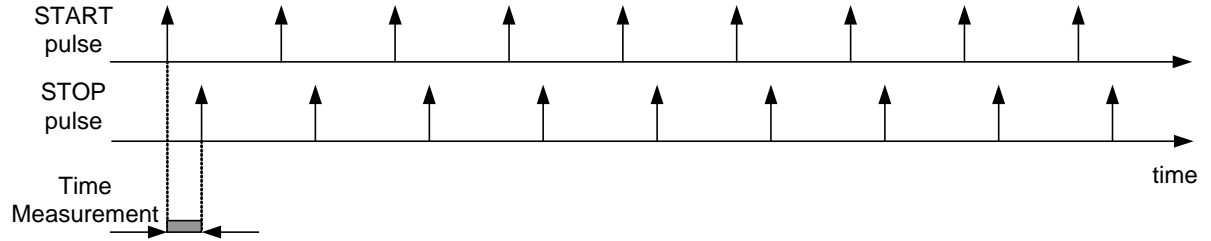

- ARM ON STOP,

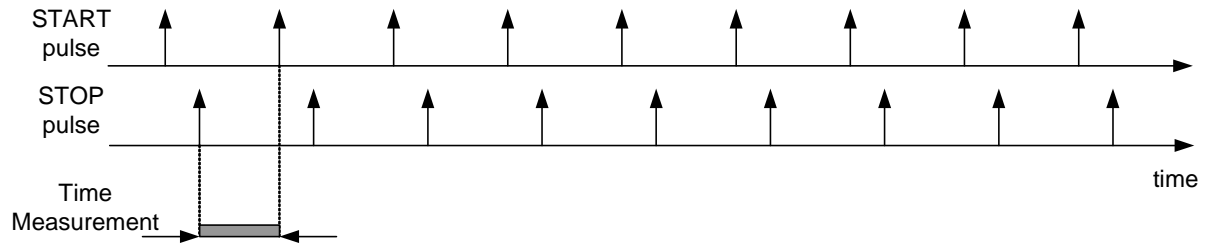

- ARM ON GATE.

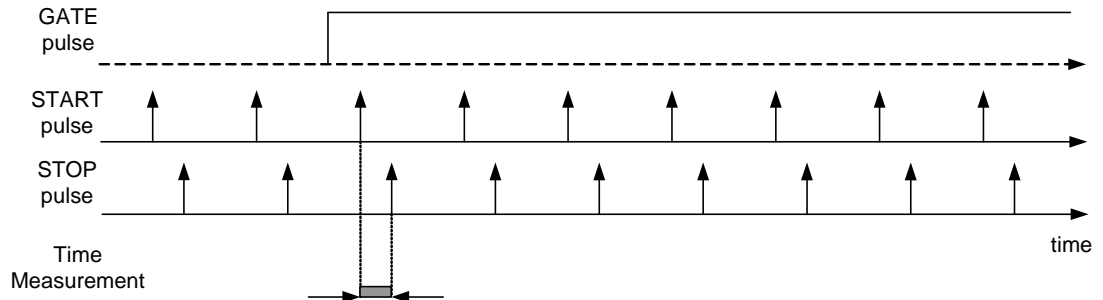

### 3.2. Front panel operation



#### 3.2.1. Interface

The front panel consists of:

L.E.D.'s,  
Keyboard and LCD display that form the dialogue components in local mode

##### 3.2.1.1. Leds

The 4 leds displays following information:

PWR BNC 1120 ON/OFF  
BUSY  
F1 CALCUL  
F2 OPTICAL MESSAGE

##### 3.2.1.2. Front panel connectors

Start: BNC connector for application of the start events.

Stop: BNC connector for application of the stop events.

Gate: BNC connector for enabling Start and Stop events.

##### 3.2.1.3. LCD display

The 2 X 20 characters LCD display is the user interface for the front panel programming operation in local mode.

##### 3.2.1.4. Keyboard

Six keys select the function

↑ ↓ will allow user to select display line or if you are in cursor mode you can increment or decrement digit selected by the cursor.

< , > will allow user to move the cursor position

**OK** set "cursor mode" or if you are already in cursor mode store the current value and clear the cursor mode. Start the measure in repetitive or single shot mode.

**Esc** clear "cursor mode" without storing the current value. Stop the measure in repetitive mode.

**3.2.2. Display menu**

G	F	T	2	0	0	2		s	n	1	0	1		V	1	.	1	.	2
---	---	---	---	---	---	---	--	---	---	---	---	---	--	---	---	---	---	---	---

2	8	.	1		°	C		-											
I	N	T	E	R	N	A	L		1	0	M	H	z						

S	T	A	R	T		E	X	T		1	.	5	0	V		+			
S	T	O	P			E	X	T		1	.	5	0	V		+			

				1	0	0		S	I	N	G	L	E						
A	R	M		O	N		S	T	A	R	T								

**3.2.2.1. Start**

S	T	A	R	T																			
T	r	i	g	g	e	r		=						I	N	H	I	B	I	T	E	D	
															I	N	T	E	R	N	A	L	
																E	X	T	E	R	N	A	L

S	T	A	R	T																		
L	e	v	e	l						1	.	5	0	V								

S	T	A	R	T																		
P	o	l	a	r	i	t	y									+						
																-						

**3.2.2.2. Stop**

S	T	O	P																			
T	r	i	g	g	e	r		=														

S	T	O	P																			
L	e	v	e	l						1	.	5	0	V								

S	T	O	P																			
P	o	l	a	r	i	t	y									+						
																-						

**3.2.2.1. Sequence measurement**

S	a	m	p	l	e	s																	
																1	0	0	0				

S	e	q	u	e	n	c	e												
S	i	n	g	l	e														
R	e	p	e	t	i	t	i	v	e										

**3.2.2.2. Arming mode**

A	r	m	i	n	g		m	o	d	e									
A	R	M		O	N		S	T	A	R	T								
A	R	M		O	N		S	T	O	P									
A	R	M		O	N		G	A	T	E									

**3.2.2.3. Measurement result**

Maximum / Minimum

				X	/		M	x	=										
				Y			M	n	=										

With X: umber of samples measured and Y: number of samples

Mean delay / Jitter

D		=		0		p	s												
J	t	=		0	.	0		p	s										

Frequency

F	r	e	q	u	e	n	c	y											
0		H	z		.														

Number of event

C	o	u	n	t	e	r													
0					.														

**3.2.3. IP adress**

G	F	T	2	0	0	2		s	n	1	0	1		v	1	.	4	.	5
---	---	---	---	---	---	---	--	---	---	---	---	---	--	---	---	---	---	---	---

Press OK and OK

I	P		A	D	R	E	S	S											
	0	9	9	.	0	0	0	.	0	0	0	.	1	2	3				

Press ^ (UP)

N	E	T		M	A	S	K												
	2	5	5	.	0	0	0	.	0	0	0	.	0	0	0				

Press ^ (UP)

G	A	T	E	W	A	Y		A	D	R	E	S	S						
	0	9	9	.	0	0	0	.	0	0	0	.	1	2	3				

Press ^ (UP)

U	S	E		D	H	C	P												
																			N O

Press ^ (UP)

S	Y	N	C		W	O	R	D											
														3	5				

Press ^ (UP)

L	A	N	G	U	A	G	E												
									E	n	g	l	i	s	h				

Press ^ (UP)

C	a	I	i	b	r	a	t	e											
P	R	E	S	S		O	K												

Press ^ (UP)

	R	E	T	U	R	N		T	O		M	A	I	N					
	M	E	N	U															

Press ^ (UP) to go IP menu  
 Press OK to go BNC 1120 menu

### 3.2.4. Default value

The default values are the following:

At factory:

- @IP: 99.0.0.18,
- @GW: 99.0.0.1,
- Mask: 255.0.0.0,

At start up:

- START: OFF,
- STOP: OFF,
- Level: 0.5 V,

## 3.3. Rear panel operation

### 3.3.1.1. Rear panel connectors

10MHZ input (BNC type): When the Rack is in external clock mode the internal oscillator will phase lock to a 10MHz signal applied to this connector

10MHZ output (BNC type): This signal is a 10 MHz square wave. It is a copy of the internal oscillator and can be used to verify the frequency or to drive another BNC 1120, which are operating, in external mode.

**Option: Optical input (SC/PC type): This optical input is compliant to GFT3001 for timing system measurement. In that mode the BNC 1120 use the clock and the triggers provided by the optical network connected to GFT3001.**

Power source: For 110 to 220 Voltages AC line.

### 3.3.1.2. Rear panel control

Power switch: Turns AC power on.



## 4. CONNECTING TO THE INSTRUMENT VIA ETHERNET

### 4.1. Command structure

#### **\*IDN?**

Syntax: \*IDN?

Form: Query

Description: Queries instrument identification. Response gives instrument model, serial number and firmware version.

Parameter: -

Example: GFTy/MIPSI,BNC 1120,SN101/000000,V1.0

Instrument model: BNC 1120

Serial number: 101,

Firmware version: 1.1

#### **ARM**

Syntax: ARM START|STOP

ARM?

Form: Set & Query

Description: Define the arming mode or ask for current arming mode.

Command START arm on start

Parameter: STOP arm on stop

Query response :ARM START arming on start

:ARM STOP arming on stop

Example: ARM START

ARM? => :ARM START

**CAL**

Syntax: CAL

Form: Set

Description: Start an auto calibration sequence.

Command Parameter: -

Query response -

Example: CAL

**COUNT**

Syntax: COUNT?

Form: Query

Description: Query the counter or frequency measurement.

Query Parameter: -

Example: COUNT? => :COUNT 32456123

**DELAY**

Syntax: DELAY? [MEAN|MIN|MAX]

Form: Query

Description: Query the delay measurement in picoseconds.

Query Parameter: MEAN return the mean value of the samples  
MIN return the minimum value of the samples  
MAX return the maximum value of the samples

Example: DELAY? MEAN => :DELAY MIN, 145  
DELAY ? => :DELAY 141,145,148

**DFORMAT**

Syntax: DFORMAT ASC|XML

Form: Set and Query

Description: Set or query the response format.

Command Parameter: ASC set the format to simple ascii  
XML set the format to XML

Example: DFORMAT ASC  
DFORMAT? => :DFORMAT ASC

**JITTER**

Syntax: JITTER? PP|RMS

Form: Query

Description: Query the jitter measurement in picosecond.

Query Parameter: PP return the peak to peak jitter of the samples  
RMS return the RMS jitter of the samples

Example: JITTER? PP => :JITTER 245

**LEVEL**

Syntax: LEVEL START|STOP,<level>  
LEVEL? START|STOP

Form: Set & Query

Description: Set or query channel trigger level.

Command Parameter: START set level for START channel  
STOP set level for STOP channel  
<level> level between 0.5 and 5.0 volts

Specified limit 0.5V <= level <= 5.0V

Example: LEVEL START,2.8  
LEVEL? START=> :LEVEL START,2.8

**MODE**

Syntax: MODE SING|REP  
MODE?

Form: Set & Query

Description: Set or query mode.

Command Parameter: SING set single measurement  
REP set repetitive measurement

Query response :MODE SING single measurement  
:MODE REP repetitive measurement

Example: MODE SING  
MODE? => :MODE SING

**POL**

Syntax: POL START|STOP,+|-  
POL? START|STOP

Form: Set & Query

Description: Set or query channel trigger polarity.

Command Parameter: START set polarity for START channel  
STOP set polarity for STOP channel  
+ set polarity to positive  
- set polarity to negative

Example: POL START,+  
POL? START=> :POL START,+

## RESULTS

Syntax: RESULTS? FLOAT,<offset>

Form: Query

Description: Query the samples measurement results.

The FLOAT query always returns real computed values.

As the query response for all samples can be very long, the query only returns 100 sample values starting at the offset specified in the query

Query Parameter: FLOAT returns the translated values of the samples

<offset> starting position for the 100 samples returned

Example: RESULTS? FLOAT,0 => RESULTS 0,12345,12346,12343,.....

**RUN**

Syntax:            RUN DELAY|FREQ|COUNT  
                       RUN?

Form:               Set & Query

Description:       Start measure or ask if measuring.

Command            DELAY start a delay measurement  
 Parameter:         FREQ start a frequency measurement  
                       COUNT start a count measurement

Query response     :RUN YES measurement running  
                       :RUN CAL calibration running  
                       :RUN NO no measurement running

Example:            RUN DELAY  
                       RUN? => :RUN YES

**SAMPLES**

Syntax:            SAMPLES <samples>  
                       SAMPLES?

Form:               Set & Query

Description:       Set or query the measurement samples.

Command            <samples> number of samples  
 Parameter:

Specified limit    1 <= samples <= 1000

Example:            SAMPLES 500  
                       SAMPLES? => :SAMPLES 500

**STAT**

Syntax: STAT CLEAR

STAT? POW|TRIG|CLK|TEMP|SCAN

Form: Set & Query

Description: Clear or query the status.

Command Parameter: CLEAR clear the trig status

SCAN, this command measure all analog values, convert analog value in digital value, save the digital value in the interface controller and refresh the value in the front panel

Query Parameter: POW return the power levels (+6V, -6V, +3.3V, +1.8V, +12V)

TRIG return the trigger status

CLK return the clock status

TEMP return the equipment temperature

Example: STAT CLEAR

STAT SCAN

STAT? POW => :STAT POW,6.00,-6.00,3.30,1.80,12.00

STAT? TRIG => :STAT TRIG,1,1

STAT? CLK => :STAT CLK,INTERNAL

STAT? TEMP => :STAT TEMP,45.27



**STOP**

Syntax: STOP

Form: Set

Description: Stop active measurement.

Command Parameter: -

Query response -

Example: STOP

**TRIG**

Syntax: TRIG START|STOP,INH|INT|EXT  
TRIG? START|STOP

Form: Set & Query

Description: Set or query channel trigger mode.

Command Parameter: START set trigger for START channel  
STOP set trigger for STOP channel  
INH trigger inhibited  
INT internal trigger (1 kHz)  
EXT external trigger

Example: TRIG START,EXT  
TRIG? START => :TRIG START,EXT

## 4.2. Remote control via Internet (web page)

BNC 1120 is controlled by 3 web pages:

- result: this page controls the instrument and displays results,
- setup: this page is to modify the setup,
- status: this page is to display some internal values and states for service people.

### 4.2.1. Results web page

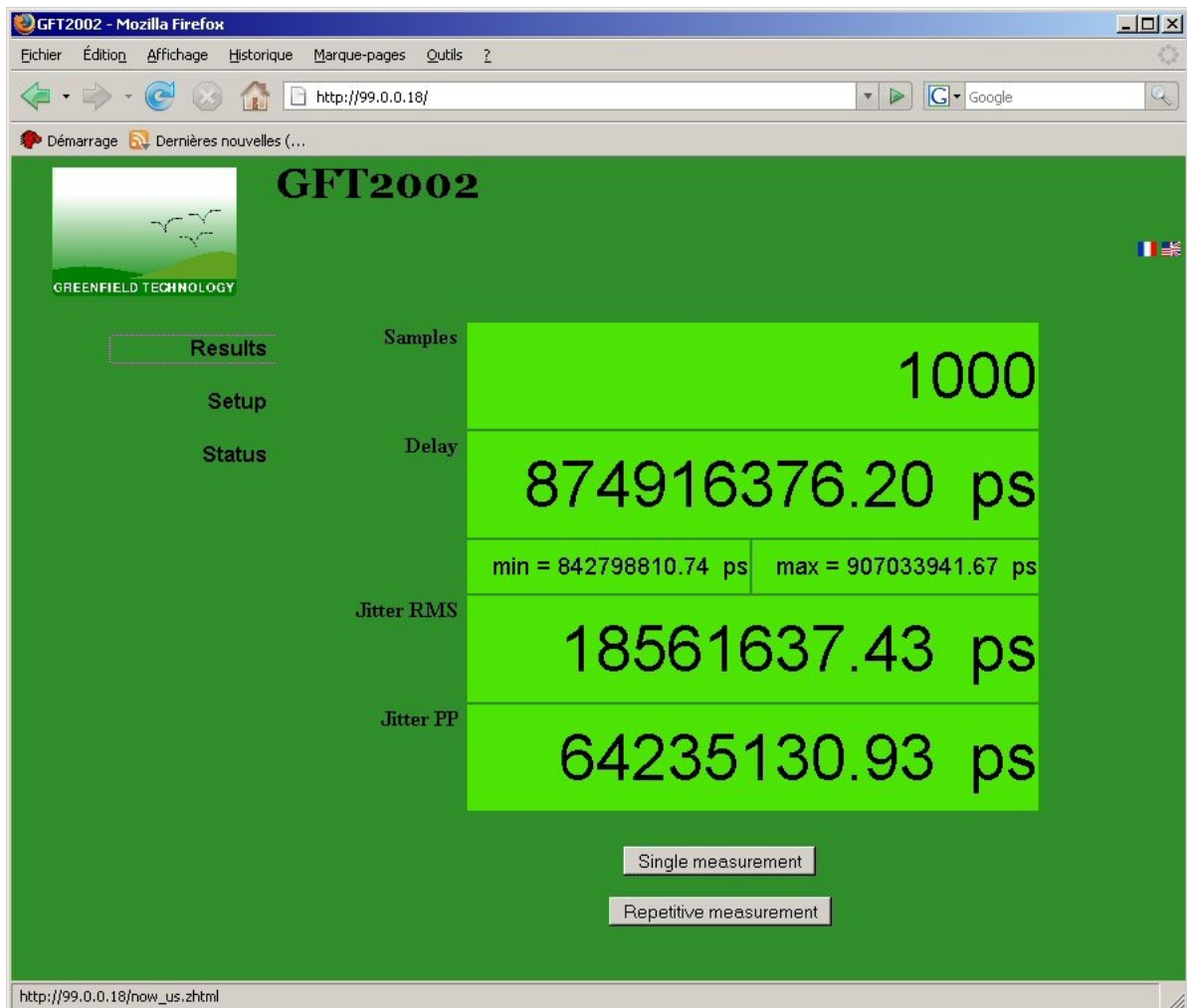

Figure 4-1 Web page: Results

### 4.2.2. Set up web page

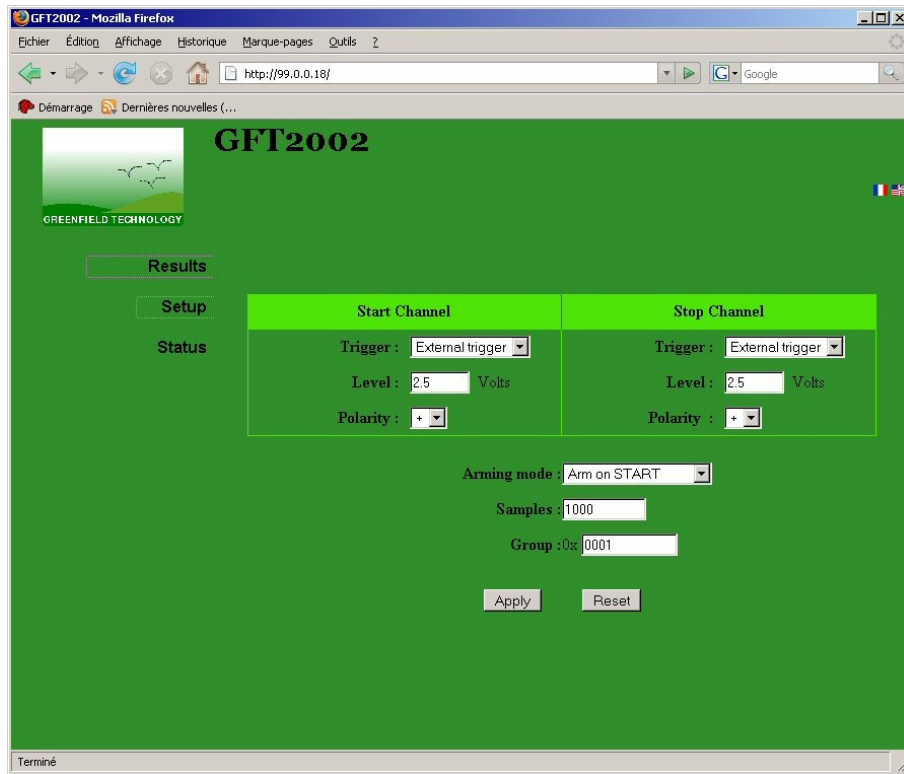

Figure 4-2 Web page: Select trigger for START and STOP

### 4.2.3. Status web page

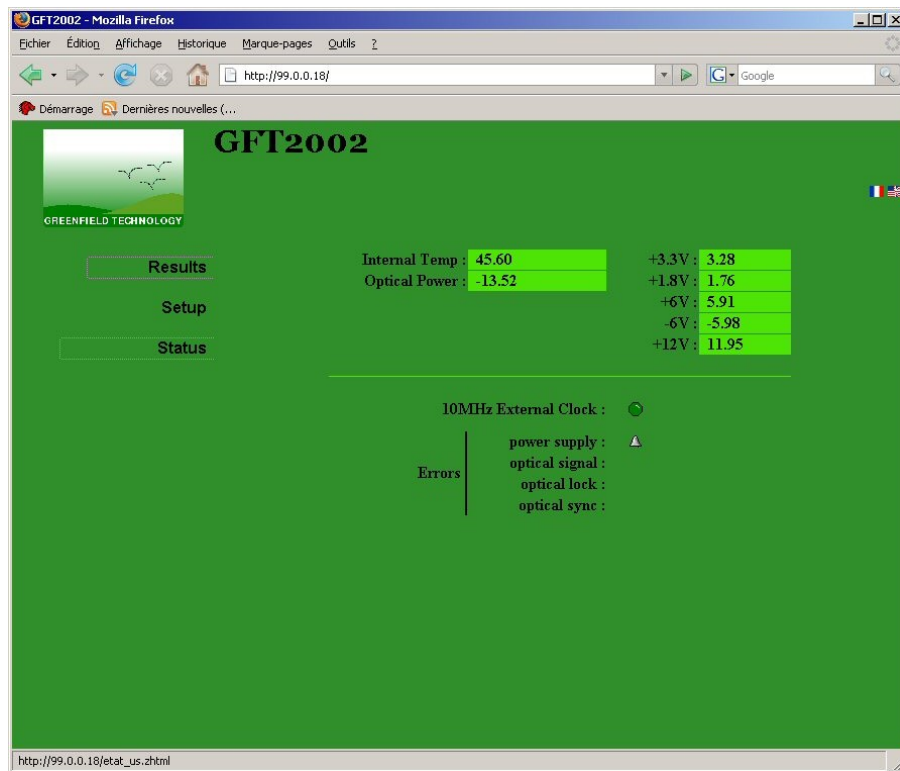

Figure 4-3 Web page: Temperature, power supply, ...

### 4.3. Remote control via Ethernet

Launch telnet.

Send the command: open ip.address 4000 if you want to dialogue with your equipment.

Send the command: open ip.address 4001 if you want to stop the connexion at the port = 4000.

Send the command: open ip.address 4002 if you want to reboot your equipment.

## 5. OPERATION EXAMPLES

### 5.1. Example 1

Realize in local mode a repetitive Time interval measurement.

#### Initial setup

Turn on the BNC 1120 with switch located on the rear panel

After few second the first line of the menu, BNC 1120 is displayed

The instrument must warm-up at least 20 minutes for maximum accuracy

#### Test signal

The operation example is performed using a test signal with following characteristics (Pulse generator):

Duration:	1000 ns,
Rise time	5 ns,
Level:	3 V,
Repetition time :	100 Hz,

This signal must be coupled with 50Ω divider then connected to **start** and **stop** input of BNC 1120

The length of the START cable = 1 m. T

#### Setting up the instrument

Use the front panel keyboard to reset the Setup menu as follows

Start trigger	External
Start level	1.50 V
Start polarity	+
Stop trigger	External
Stop level	1.50 V
Stop polarity	+
Samples	1000
Sequence	repetitive
Arming mode	on start

#### Start the measurement

Display the result line Mean delay / jitter, and press the OK keys to start the measurement

The front panel leds busy must be on and tilt each second

Result must be

Delay = 5 200 ns

Jitter = 8 ps rms

For stopping the measurement press the **ESC** key

## 5.2. Example 2

Realize in local mode a frequency measurement on start input  
Same initial set-up and test signal as for example n°1

### Setting up the instrument

Use the front panel keyboard to reset the Setup menu as follows

Start trigger	External
Start level	1.50 V
Start polarity	+

### Start the measurement

Display the result line frequency, and press the OK keys to start the measurement

The front panel leds busy must be on and tilt each second

Result must be

Frequency = 100 Hz

For stopping the measurement press the OK key

**6. ANNEXE : OPTION 1 OPTICAL MESSAGE**

**6.1. Front panel operation**

**6.1.1. Display menu**

G	F	T	2	0	0	2		s	n	1	0	1		V	1	.	1	.	2

2	8	.	1		°	C		-	5	6	.	8		d	B	m			
I	N	T	E	R	N	A	L		1	0	M	H	z						

S	T	A	R	T		E	X	T		1	.	5	0	V		+			
S	T	O	P			E	X	T		1	.	5	0	V		+			

				1	0	0		S	I	N	G	L	E						
A	R	M		O	N			S	T	A	R	T							

**6.1.1.1. Start**

S	T	A	R	T															
T	r	i	g	g	e	r	=			I	N	H	I	B	I	T	E	D	
										I	N	T	E	R	N	A	L		
										E	X	T	E	R	N	A	L		
												R	E	P		F	1		
												R	E	P		F	2		
												R	E	P		F	3		
										S	I	N	G	L	E			1	
										S	I	N	G	L	E			2	

S	T	A	R	T															
L	e	v	e	l					1	.	5	0		V					

S	T	A	R	T															
P	o	l	a	r	i	t	y							+					
														-					

**6.1.1.2. Stop**

S	T	O	P																
T	r	i	g	g	e	r	=			I	N	H	I	B	I	T	E	D	
										I	N	T	E	R	N	A	L		
										E	X	T	E	R	N	A	L		
												R	E	P		F	3		
												R	E	P		F	2		
												R	E	P		F	3		
										S	I	N	G	L	E			1	
										S	I	N	G	L	E			2	

S	T	O	P																
L	e	v	e	l					1	.	5	0		V					

S	T	O	P																
P	o	l	a	r	i	t	y							+					
														-					

**6.1.1.3. Sequence measurement**

S	a	m	p	l	e	s													
										1	0	0	0						



S	e	q	u	e	n	c	e												
S	i	n	g	l	e														
R	e	p	e	t	i	t	i	v	e										

**6.1.1.4. Arming mode**

A	r	m	i	n	g		m	o	d	e									
A	R	M		O	N		S	T	A	R	T								
A	R	M		O	N		S	T	O	P									
A	R	M		O	N		G	A	T	E									

**6.1.1.5. Measurement result**

Maximum / Minimum

				X	/		M	x	=										
				Y			M	n	=										

With X: umber of samples measured and Y: number of samples

Mean delay / Jitter

D		=		0		p	s												
J	t	=		0	.	0		p	s										

Frequency

F	r	e	q	u	e	n	c	y											
0		H	z		.														

Number of event

C	o	u	n	t	e	r													
0				.															

**6.1.1.6. Historical command**

G	R	O	U	P															
				.														1	

**6.1.2. IP adress**

G	F	T	2	0	0	2		s	n	1	0	1		v	1	.	4	.	5
---	---	---	---	---	---	---	--	---	---	---	---	---	--	---	---	---	---	---	---

Press OK and OK

I	P		A	D	R	E	S	S											
	0	9	9	.	0	0	0	.	0	0	0	.	1	2	3				

Press ^ (UP)

N	E	T		M	A	S	K												
	2	5	5	.	0	0	0	.	0	0	0	.	0	0	0				

Press ^ (UP)

G	A	T	E	W	A	Y		A	D	R	E	S	S						
	0	9	9	.	0	0	0	.	0	0	0	.	1	2	3				

Press ^ (UP)

U	S	E		D	H	C	P													
																			N	O

Press ^ (UP)

S	Y	N	C		W	O	R	D											
														3	5				

Press ^ (UP)

L	A	N	G	U	A	G	E												
									E	n	g	l	i	s	h				

Press ^ (UP)

C	a	I	i	b	r	a	t	e											
P	R	E	S	S		O	K												

Press ^ (UP)

	R	E	T	U	R	N		T	O		M	A	I	N					
	M	E	N	U															

Press ^ (UP) to go IP menu  
 Press OK to go BNC 1120 menu

### 6.1.3. Command structure

#### STAT

Syntax: STAT CLEAR

STAT? POW|TRIG|CLK|TEMP|POPT|SYN

Form: Set & Query

Description: Clear or query the status.

Command Parameter: CLEAR: clear the trig status

Query Parameter: SYN return the synthesis word

- 01 power fault
- 02 sync error
- 04 inhibited

POW return the power levels (+6V, -6V, +3.3V, +1.8V, +12V)

TRIG return the trigger status

CLK return the clock status

TEMP return the equipment temperature

POPT return the optical received power

Example: STAT CLEAR

STAT? SYN => :STAT SYN,#H0001

STAT? POW => :STAT POW,6.00,-6.00,3.30,1.80,12.00

STAT? TRIG => :STAT TRIG,1,1

STAT? CLK => :STAT CLK,INTERNAL

STAT? POPT => :STAT POPT,4.54

STAT? TEMP => :STAT TEMP,45.27

**SYNC**

Syntax: SYNC <syncword>  
 SYNC?

Form: Set & Query

Description: Set or query the sync word for optical channel.

Command Parameter: <sync> sync word (format #Hxx)

Example: SYNC #H35  
 SYNC? => :SYNC #H35

**TRIG**

Syntax: TRIG START|STOP,INH|INT|EXT|F1|F2|F3|SS1|SS2  
 TRIG? START|STOP

Form: Set & Query

Description: Set or query channel trigger mode.

Command Parameter: START set trigger for START channel  
 STOP set trigger for STOP channel  
 INH trigger inhibited  
 INT internal trigger (1 kHz)  
 EXT external trigger  
 F1,F2,F3 trigger on frequency 1, 2 or 3  
 SS1 trigger on SS1 signal  
 SS2 trigger on SS2 signal

Example: TRIG START,EXT  
 TRIG? START => :TRIG START,EXT